

TOSHIBA

TOSHIBA Barcode Printer

BA410T SERIES

Owner's Manual



CE Compliance (for EU only)

This product is labelled with the CE mark in accordance with the provisions of the applicable European Directives, notably the Radio Equipment Directive 2014/53/EU, the RoHS Directive 2011/65/EU, (EU) 2015/863 for this product and the electric accessories.

CE marking is the responsibility of TOSHIBA TEC GERMANY IMAGING SYSTEMS GmbH, Carl-Schurz-Str. 7, 41460 Neuss, Germany, phone +49-(0)-2131-1245-0.

For a copy of the related CE Declaration of Conformity, please contact your dealer or TOSHIBA TEC.

VORSICHT:

- Die für das Gerät Vorgesehene Steckdose muß in der Nähe des Gerätes und leicht zugänglich sein.

Centronics is a registered trademark of Centronics Data Computer Corp.

Microsoft is a registered trademark of Microsoft Corporation.

Windows is a trademark of Microsoft Corporation.

This equipment has been tested and found to comply with the limits for a Class A digital device, pursuant to Part 15 of the FCC Rules. These limits are designed to provide reasonable protection against harmful interference when the equipment is operated in a commercial environment. This equipment generates, uses, and can radiate radio frequency energy and, if not installed and set in accordance with the instruction manual, may cause harmful interference to radio communications. Operations of this equipment in a residential area is likely to cause harmful interference in which case the user will be required to correct the interference at his own expense.

(for USA only)

Changes or modifications not expressly approved by the manufacturer for compliance could void the user's authority to operate the equipment.

(for USA only)

"This Class A digital apparatus meets all requirements of the Canadian Interference-Causing Equipment Regulations."

"Cet appareil numérique de la classe A respecte toutes les exigences du Règlement sur le matériel brouilleur du Canada."

(for CANADA only)

California Proposition 65: USA-California only

WARNING :

This product can expose you to chemicals including DINP which is known to the State of California to cause cancer. For more information go to www.P65Warnings.ca.gov.

California Perchlorate Material Notice: USA-California only

Perchlorate Material - special handling may apply.

See <http://www.dtsc.ca.gov/hazardouswaste/perchlorate/>



**Complies with
IMDA Standards
DA105848**



This symbol is applicable for EU member states only”
Battery users must not dispose of batteries as unsorted general waste, but treat properly.”

La siguiente información es solo para Argentina:



El uso de este símbolo indica que este producto no puede ser tratado como residuos domésticos. Asegúrese que este producto se deseché correctamente, Usted ayudara a evitar posibles consecuencias negativas para el medio ambiente y la salud humana, que podrian derivarse de la incorrecta manipulación de este producto.

Para mas información sobre el reciclaje de este producto, consulte con nuestro su distribuidor donde adquirió el producto.

Following information is only for India:

The use of the symbol indicates that this product may not be treated as household waste. By ensuring this product is disposed of correctly, you will help prevent potential negative consequences for the environment and human health, which could otherwise be caused by inappropriate waste handling of this product.

For more detailed information about the take-back and recycling of this product, please contact your supplier where you purchased the product.

This product including components, consumables, parts and spares complies with the “India E-Waste Rules ” and prohibits use of lead, mercury, hexavalent chromium, polybrominated biphenyls or polybrominated diphenyl ethers in concentrations exceeding 0.1% by weight and 0.01% by weight for cadmium, except for the exemption set in the Rule.



Waste Recycling information for users:

Following information is only for EU-member states:

The use of the crossed-out wheeled bin symbol indicates that this product may not be treated as general household waste.

By ensuring this product is disposed of correctly you will help prevent potential negative consequences for the environment and human health, which could otherwise be caused by inappropriate waste handling of this product. For more detailed information about the take-back and recycling of this product, please contact your supplier where you purchased the product.



Precautions for the handling of Wireless Communication Devices

Wireless LAN Board: BA700-WLAN-QM-S

RFID : BA704-RFID-U4-KR-S, BA704-RFID-U4-EU-S, BA704-RFID-U4-AU-S

Bluetooth: BA410T-GS12-QM-S, BA410T-TS12-QM-S

For Europe

This device was tested and certified by Notified Body.



Hereby, Toshiba TEC Corporation declares that this device is in compliance with the essential requirements and other relevant provisions.

This equipment uses the radio frequency band which has not been standardized throughout the EU and EFTA countries.

For Mexico

“La operación de este equipo está sujeta a las siguientes dos condiciones:

- (1) es posible que este equipo o dispositivo no cause interferencia perjudicial y
- (2) este equipo o dispositivo debe aceptar cualquier interferencia, incluyendo la que pueda causar su operación no deseada.”

Bluetooth Module	WLAN Module
<p><u>Precaución para su uso en México</u> Módulo Bluetooth instalado adentro de esta instrument Fujitsu Component Limited, MBH7BTZ42  IFETEL RCPFUMB19-0018</p>	<p><u>Precaución para su uso en México</u> Módulo WLAN instalado adentro de esta instrument REDPINE SIGNALS, RS9113DB  IFETEL RCPRERS18-0642</p>

For safety

Do not operate this product in locations where its use may be prohibited. For example, in an aeroplane or hospital. If you are unsure whether operation is permitted, please refer to and follow the airline company or medical institution guidelines.

Otherwise, flight instrument or medical equipment may be affected, causing a serious accident.

This product may affect the operation of some implanted cardiac pacemakers and other medically implanted equipment. Pacemaker patients should be aware that the use of this product in close proximity to a pacemaker might cause the device to malfunction.

If you have any reason to suspect that interference is taking place, immediately turn off the product and contact your TOSHIBA TEC sales agent.

Do not disassemble, modify, or repair the product as doing so may cause injury.

Modification is also against the Laws and Regulations for Radio Equipment. Please ask your TOSHIBA TEC sales agent for repair.

TABLE OF CONTENTS

	Page
1. PRODUCT OVERVIEW	E1- 1
1.1 Introduction.....	E1- 1
1.2 Features	E1- 1
1.3 Accessories	E1- 2
1.4 Appearance	E1- 3
1.4.1 Dimensions.....	E1- 3
1.4.2 Front View	E1- 3
1.4.3 Rear View.....	E1- 3
1.4.4 Operation Panel	E1- 4
1.4.5 Interior	E1- 4
1.5 Options	E1- 5
2. PRINTER SETUP	E2- 1
2.1 Installation	E2- 2
2.1.1 Attaching the Printer Rear Support.....	E2- 2
2.2 Connecting the Power Cord.....	E2- 2
2.3 Loading the Media	E2- 3
2.4 Loading the Ribbon	E2-11
2.5 Connecting the Printer to Your Host Computer	E2-14
2.6 Turning the Printer ON.....	E2-15
3. MAINTENANCE	E3- 1
3.1 Cleaning	E3- 1
3.1.1 Print Head/Platen/Sensors.....	E3- 1
3.1.2 Covers and Panels.....	E3- 2
3.1.3 Optional Cutter Module	E3- 3
3.1.4 Optional Strip Module.....	E3- 4
4. TROUBLESHOOTING	E4- 1
4.1 Error Messages	E4- 1
4.2 Possible Problems.....	E4- 3
4.3 Removing Jammed Media	E4- 4
5. PRINTER SPECIFICATIONS	E5- 1
6. APPENDIX1 INTERFACE	E6- 1
7. APPENDIX2 POWER CORD	E7- 1

 **WARNING!**

This is a Class A product. In a domestic environment this product may cause radio interference in which case the user may be required to take adequate measures.

 **CAUTION!**

1. *This manual may not be copied in whole or in part without prior written permission of TOSHIBA TEC.*
2. *The contents of this manual may be changed without notification.*
3. *Please refer to your local Authorised Service representative with regard to any queries you may have in this manual.*

1. PRODUCT OVERVIEW

1.1 Introduction

Thank you for choosing the TOSHIBA BA410T series barcode printer. This Owner's Manual contains from general set-up through to how to confirm the printer operation using a test print, and should be read carefully to help gain maximum performance and life from your printer. For most queries please refer to this manual and keep it safe for future reference. Please contact your TOSHIBA TEC representative for further information concerning this manual.

1.2 Features

This printer has the following features:

• Space-saving design

The area required to allocate this printer is about the same as an A4 sheet of paper, even with both media and ribbon loaded. The Top Cover opens upward, which also reduces the space needed for installation.

The optional cutter module and strip module are as slim and small and fit inside the printer keeping the size compact.

• Various interfaces possible

The following interfaces are available:

<Standard>

- Bluetooth
- USB
- Built-in LAN

<Option>

- Serial
- Wireless LAN
- Expansion I/O
- Parallel

• Superior hardware

Specially developed 8 dots/mm (203 dpi) (BA410T-GS12) or 11.8 dots/mm (300 dpi) (BA410T-TS12) print head enable very clear print, at a printing speed of 50.8 mm/sec. (2 inches/sec.), 101.6 mm/sec. (4 inches/sec.), 152.4 mm/sec. (6 inches/sec.) or 203.2mm/sec (8 inches/sec).

• Heavy-duty enclosure

As the enclosure is made of metal, the printer can be used in an industrial environment such as a factory.

• Easy maintenance

The printer is designed to be very easy to use. Especially, maintenance simplified by the ease to attach and remove of the print head and platen.

• Additional of options

The following optional devices are available:

- Cutter module
- Strip module
- Serial interface board
- Wireless LAN board
- Expansion I/O board
- Real Time Clock
- Parallel interface board
- UHF RFID Module
- Fanfold Guide

1.3 Accessories

When unpacking the printer, please make sure all the following accessories are supplied with the printer.

NOTE:
 As a power cord is not supplied with this printer, please purchase one that meets each country's safety standard. For details, refer to **APPENDIX 2**.

- Start-up CD-ROM (1 pc.)

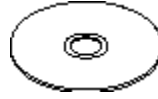

<Contents>

- Bar code print application (Bartender ultra-lite)
- Windows Driver
- Owner's Manual
- Specifications (Programming, Key operation, etc.)
- Product information
- Safety Precaution (Each Language)

- Simple DOC

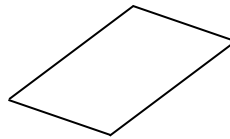

- Safety Precautions

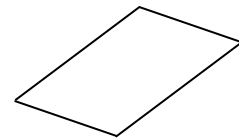

- OpenType Font License Guide (1 sheet)

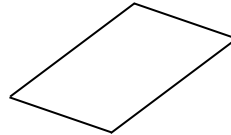

- Owner's manual

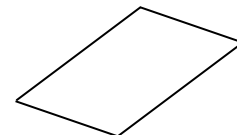

1.4 Appearance

The names of the parts or units introduced in this section are used in the following chapters.

1.4.1 Dimensions

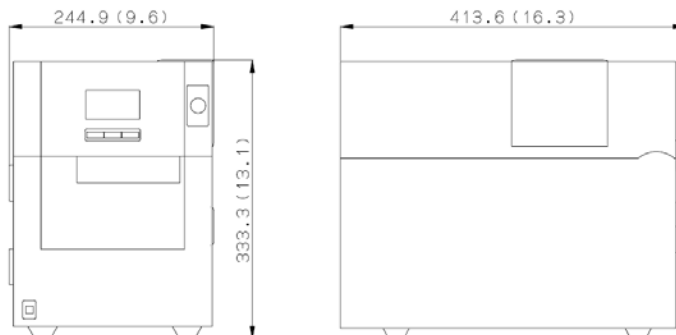

Dimensions in mm (inches)

1.4.2 Front View

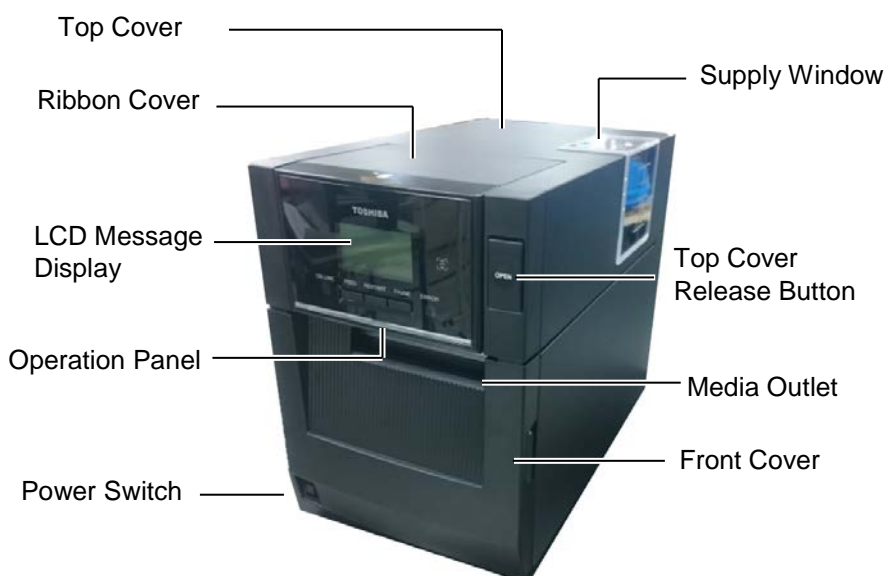

1.4.3 Rear View

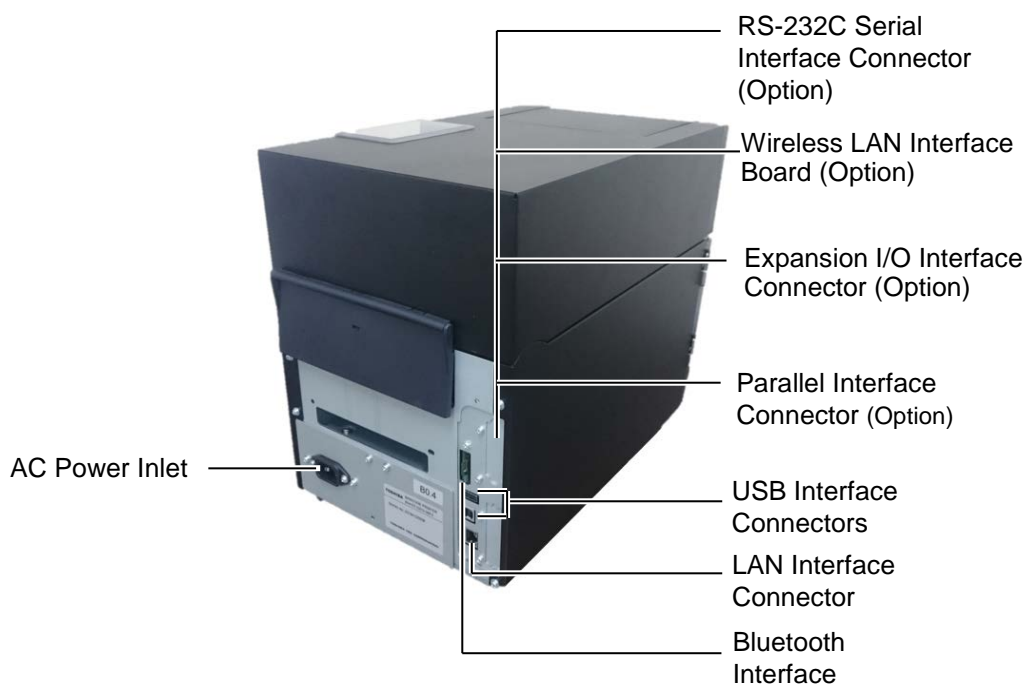

1.4.4 Operation Panel

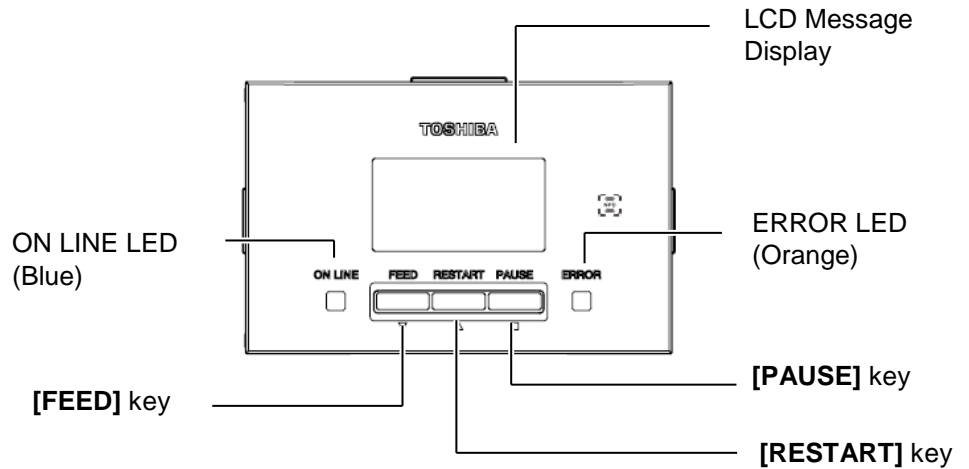

Please see **Section 4.1** for further information about the Operation Panel.

1.4.5 Interior

⚠ WARNING!

- Do not touch the Print Head or around it just after printing. You may get burned as the Print Head becomes very hot during printing.
- Do not touch any moving parts. To reduce the risk of fingers, jewellery, clothing, etc., being drawn into the moving parts, be sure to load the media once the printer has stopped moving completely.
- To avoid injury, be careful not to trap your fingers while opening or closing the cover.
- 
 - Hot Part
 - You may get burned
 - The stepping motor will become very hot after media is issued continuously for about 1 hour. Care must be taken not to touch it when the front cover is opened

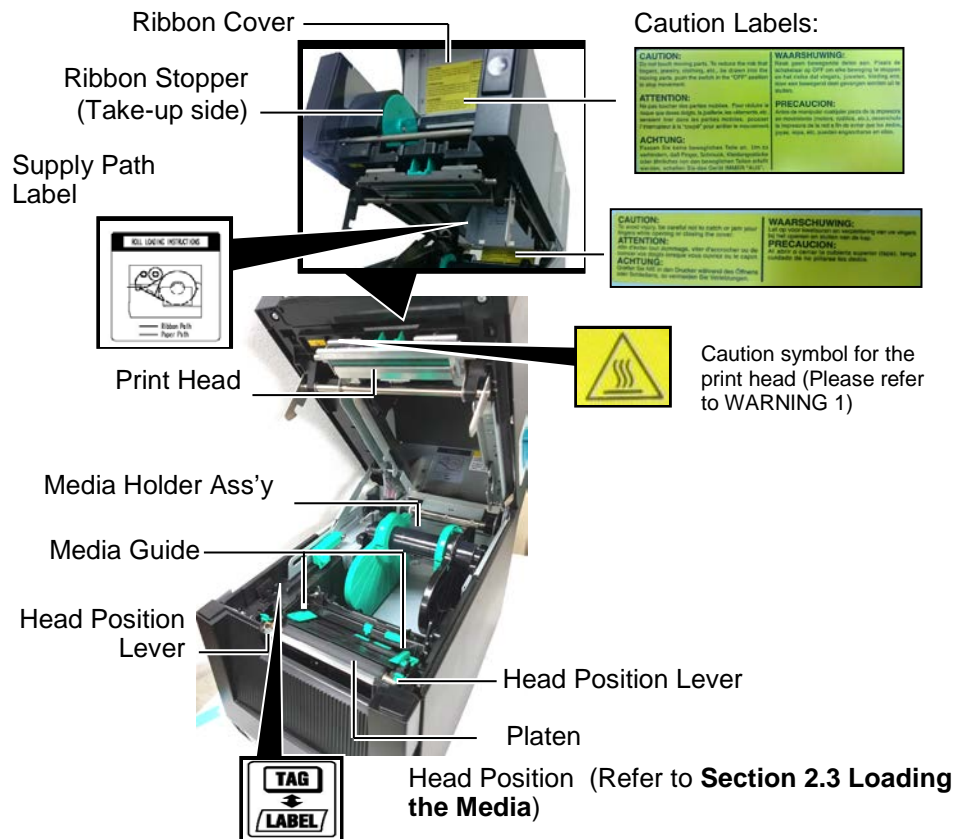

1.5 Options

Option Name	Type	Usage
Cutter module	BA204-QM-S	A guillotine cutter which cuts the media. This module is slim and compact enough to fit inside the Front Cover.
Strip module	BA904-H-QM-S	This module peels off a printed label from the backing paper at the media outlet. It is slim and compact enough to be fitted in the Front Cover.
Serial Interface Board	BA700-RS-QM-S	Installing this PC board provides an RS232C interface port.
Wireless LAN Board	BA700-WLAN-QM-S	Installing this PC board allows a communication by wireless LAN.
Expansion I/O Board	BA700-IO-QM-S	Installing this board in the printer allows a connection with an external control device is a signal interface.
Real Time Clock	BA700-RTC-QM-S	This module holds the current time: year, month, day, hour, minute, second
Fan Fold Guide	BA904-FF-QM-S	Guide insert media from outside the printer.
Parallel Interface (CEN)	BA700-CEN-QM-S	Installing this card provides a Centronics interface port.
UHF RFID Module	BA704-RFID-U4-KR-S BA704-RFID-U4-EU-S BA704-RFID-U4-AU-S	Installing this module enables reading and writing of UHF RFID tags.

2. PRINTER SETUP

This section outlines the procedures to setup your printer prior to its operation. The section includes precautions, loading media and ribbon, connecting cables, setting the operating environment of the printer, and performing an online print test.

Setup Flow	Procedure	Reference
Installation	After referring to the Safety Precautions in this manual, install the printer on a safe and stable location.	2.1 Installation
Connecting the power cord	Connect a power cord to the power inlet of the printer, then, to an AC outlet.	2.2 Connecting the Power Cord
Loading the media	Load a label stock or tag stock.	2.3 Loading the Media
Media sensor position alignment	Adjust the position of feed gap sensor or black mark sensor according to the media to be used.	2.3 Loading the Media
Loading the ribbon	If using thermal transfer media then load the ribbon	2.4 Loading the Ribbon
Connecting to a host computer	Connect the printer to a host computer or a network.	2.5 Connecting the Printer to Your Host Computer
Turning the power ON	Turn on the printer power.	2.6 Turning the Power ON
Setting the operating environment	Set the printer parameters in the system mode.	
Installing the printer driver	If necessary, install the printer driver in your host computer.	
Print test	Make a print test in your operating environment and check the print result.	
Position and Print Tone Fine adjustment	If necessary, fine adjust the print start position, cut/strip position, print tone, etc.	
Automatic threshold setting	If the print start position cannot be detected properly when pre-printed label is used, set the threshold automatically.	
Manual threshold setting	If the print start position cannot be detected properly even an automatic threshold setting is performing, manually set the threshold.	

2.1 Installation

To insure the best operating environment, and to assure the safety of the operator and the equipment, please observe the following precautions.

- Operate the printer on a stable, level surface in a location free from excessive humidity, high temperature, dust, vibration and direct sunlight.
- Keep your work environment static free. Static discharge can cause damage to delicate internal components.
- Make sure that the printer is connected to a clean source of AC Power and that no other high voltage devices that may cause line noise interference are connected to the same mains.
- Assure that the printer is connected to the AC mains with a three-prong power cable that has the proper ground (earth) connection.

1. Connect the Power Cord to the printer as shown in the figure below

2.2 Connecting the Power Cord

⚠ CAUTION!

*As a Power Cord is not supplied with the printer, please purchase an approved one that meets the safety standard of each country. (Refer to **APPENDIX 2.**)*



Power Switch



Power Cord

2. Plug the other end of the Power Cord into a grounded outlet as shown in the figure below.

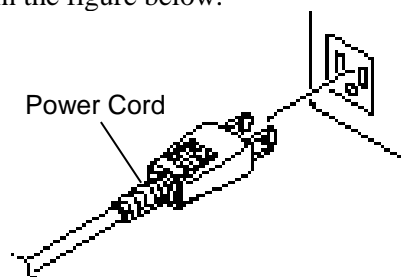

[Example of US Type]

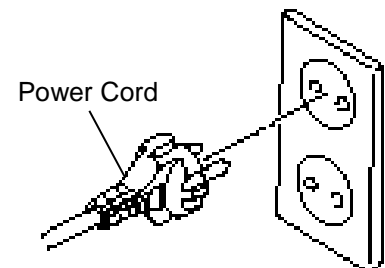

[Example of EU Type]

2.3 Loading the Media

⚠ WARNING!

1. Do not touch any moving parts. To reduce the risk of fingers, jewellery, clothing, etc., being drawn into the moving parts, be sure to load the media once the printer has stopped moving completely.
2. The Print Head becomes hot immediately after printing. Allow it to cool before loading the media.
3. To avoid injury, be careful not to trap your fingers while opening or closing the cover.

⚠ CAUTION!

1. Make sure that the Upper Sensor Ass'y is closed when taking out the Media Holder Ass'y. If the Upper Sensor Ass'y is opened, it may be damaged.
2. Be careful not to touch the Print Head Element when opening the Top Cover. Failure to do this may cause missing dots by static electricity or other print quality problems.

The following procedure shows the steps to properly load the media into the printer so that it feeds straight and true through the printer. Use the same procedure when replacing the media, also. The printer prints both labels and tags.

1. Press the Top Cover Release Button and gently open the Top Cover to its fully open position supporting it with your hand.

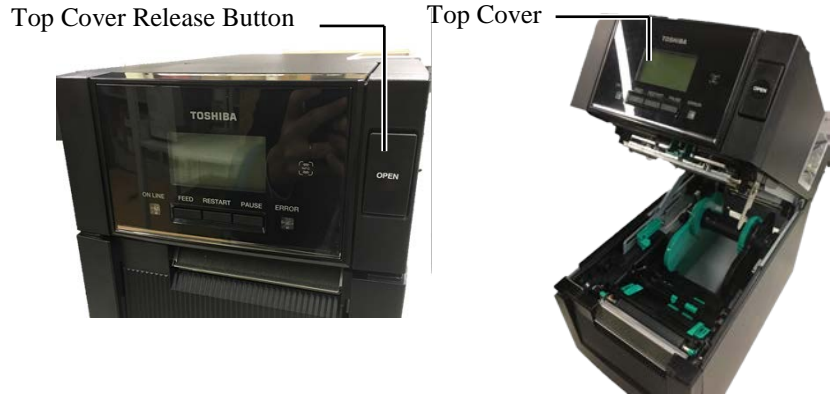

2. Take out the Media Holder Ass'y from the printer.

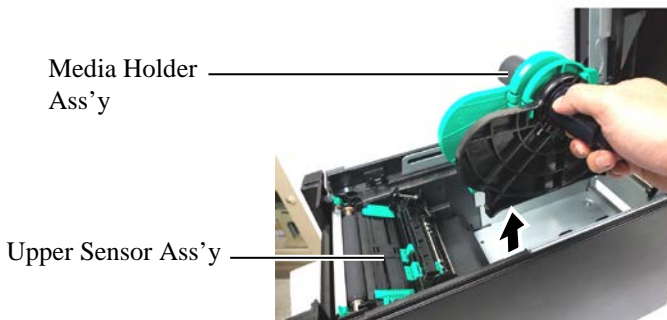

3. Raise the Release Lever and remove the Media Holder (Left).

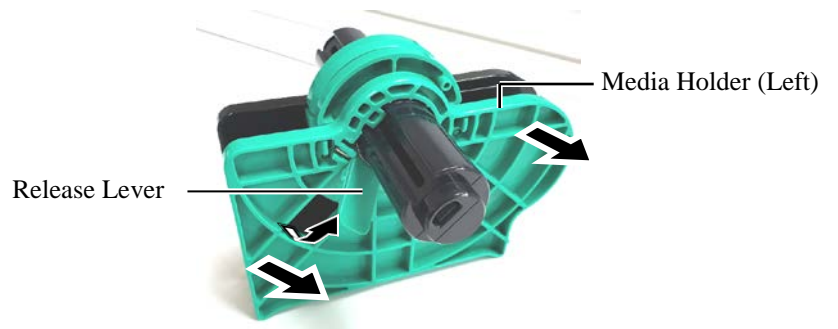

4. Insert the Media Shaft into the core of a media roll.

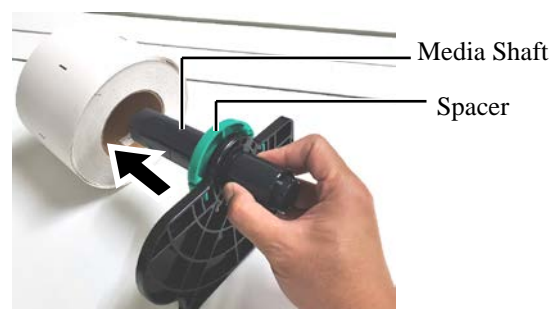

2.3 Loading the Media (Cont.)

- Put the Media Holder (Left) onto the Media Shaft. Push the Media Holder (Left) and the Media Holder (Right) against the media until the media is held firmly in place. This will automatically center the media.

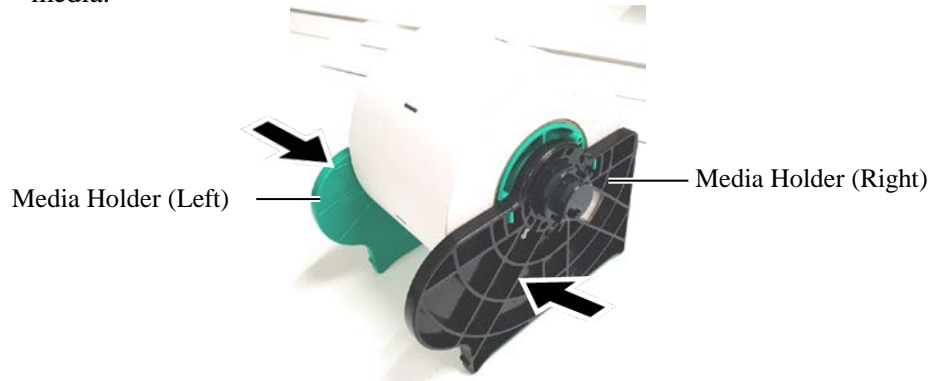

- Fold the Release Lever to lock the Media Holder (Left).

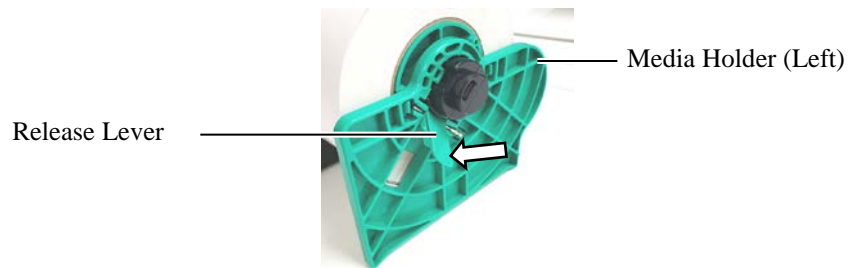

- Place the Media Holder Ass'y into the printer.



⚠ CAUTION!
 Make sure that the Upper Sensor Ass'y is closed when placing the Media Holder Ass'y into the printer. If the Upper Sensor Ass'y is opened, it may be damaged.

NOTE:
 Be careful of the orientation of the Media Holder Ass'y and the media.

- Slightly push the Upper Sensor Lever inside (①), and open the Upper Sensor Ass'y (②).

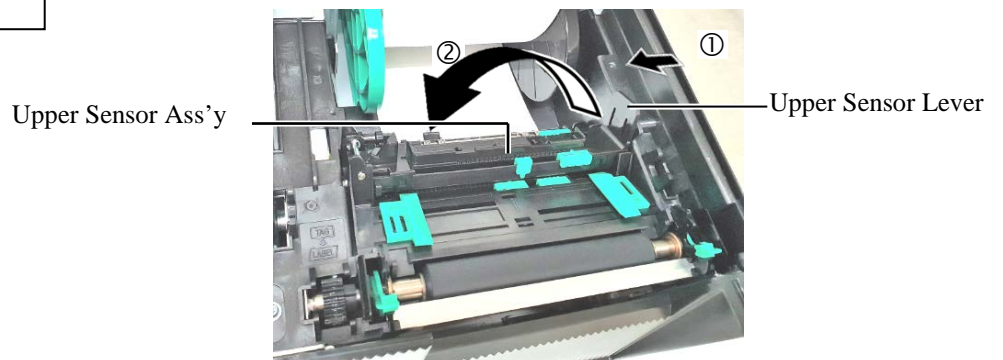

2.3 Loading the Media (Cont.)

9. Pull the media out of the front of the printer, and adjust the Media Guides to the media width. This will automatically center the media.

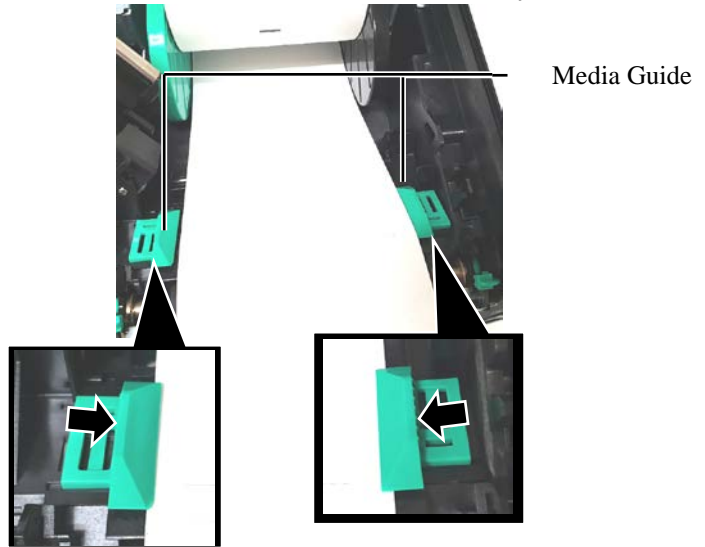

⚠ CAUTION!
Be sure to close the Upper Sensor Ass'y before closing the Top Cover. If the Upper Sensor Ass'y is opened, it may be damaged.

NOTE:
Make sure that the Upper Sensor Ass'y is locked. If it is unlocked, a paper jam or print failure may occur.

10. Lower the Upper Sensor Ass'y until the Upper Sensor Lever clicks into position.

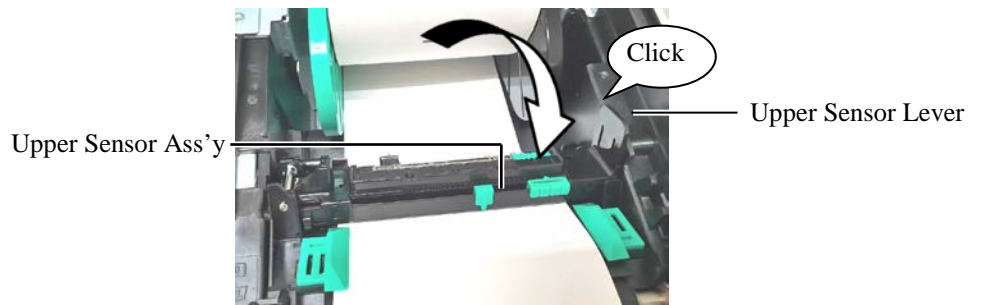

2.3 Loading the Media (Cont.)

11. After loading the media, it may be necessary to set the position of the Media Sensor used to detect the print start position for label or tag printing.

Setting the Feed Gap Sensor position

When using a label stock without black marks, the Feed Gap Sensor is used to detect a print start position.

- (1) Push the Upper Sensor Lever inside and open the Upper Sensor Ass'y.
- (2) Slide the Lower Sensor Tab with your finger to move the Feed Gap Sensor so that the Feed Gap Sensor is positioned at the center of the labels. (O indicates the position of the Feed Gap Sensor).

It may be easier to move the Lower Sensor Tab if you use a pen inserting its tip into the pinhole of the tab.

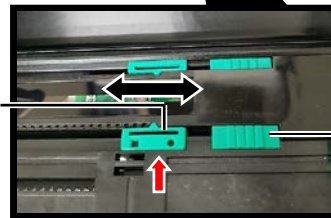
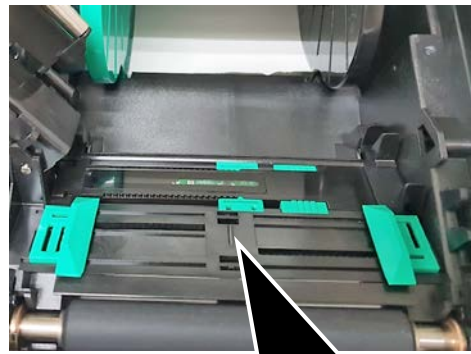

Feed Gap Sensor

Lower Sensor Tab

NOTE:

Be sure to align the Upper Feed Gap Sensor with the Lower Feed Gap Sensor. Failure to do this cause a paper jam error.

- (3) Lower the Upper Sensor Ass'y until the Upper Sensor Lever clicks into position.
- (4) Slide the Upper Sensor Tab to move the Feed Gap Sensor so that it aligns with the lower Feed Gap Sensor.

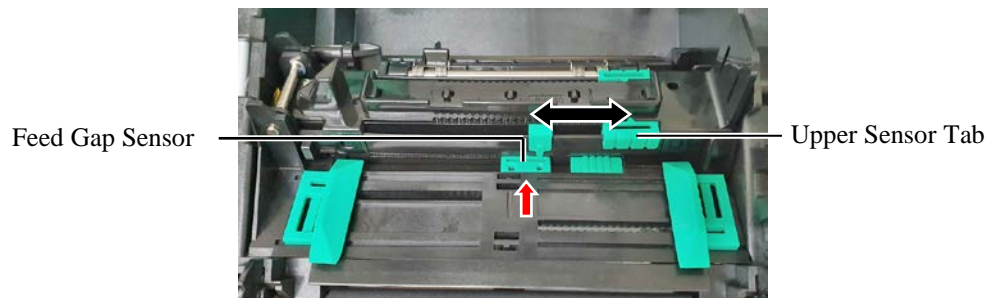

Feed Gap Sensor

Upper Sensor Tab

2.3 Loading the Media (Cont.)

NOTES:

1. Be sure to set the Black Mark Sensor to detect the centre of the black mark, otherwise a paper jam or no paper error may occur.
2. After adjusting the Black Mark Sensor position, align the Upper Feed Gap Sensor with the Lower Feed Gap Sensor. This is because a paper end is detected by the Feed Gap Sensor.

Setting the Black Mark Sensor position

When using media with black marks, the Black Mark Sensor is used to detect a print start position.

- (1) Push the Upper Sensor Lever inside and open the Upper Sensor Ass'y.
- (2) Check the reverse side of the media for the black mark position.
- (3) Slide the Lower Sensor Tab to move the Black Mark Sensor so that it is in line with the center of the black mark on the media.
( indicates the position of the Black Mark Sensor).

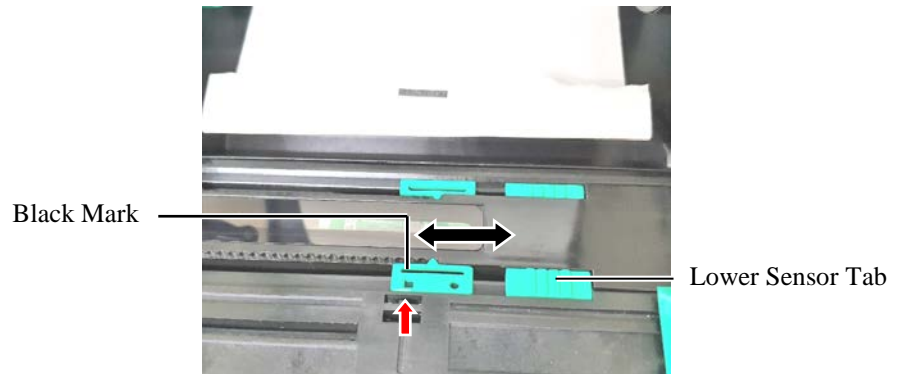

- (4) Lower the Upper Sensor Ass'y until the Upper Sensor Lever clicks in position.

2.3 Loading the Media (Cont.)

12. There are three issue modes available on this printer. How to set the media for each mode is provided below.

Batch mode

In the batch mode, the media is continuously printed and fed until the number of labels/tags specified in the issue command have been printed.

- (1) Pull the top edge of the media past the Platen.

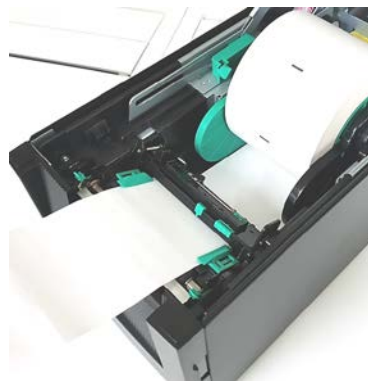

- (2) Close the Top Cover until it clicks.



Strip mode (Option)

When the optional Strip Module is fitted, a label is automatically removed from the backing paper at the Strip Plate as each label is printed.

- (1) Open the Front Cover holding its right side. (*Note)

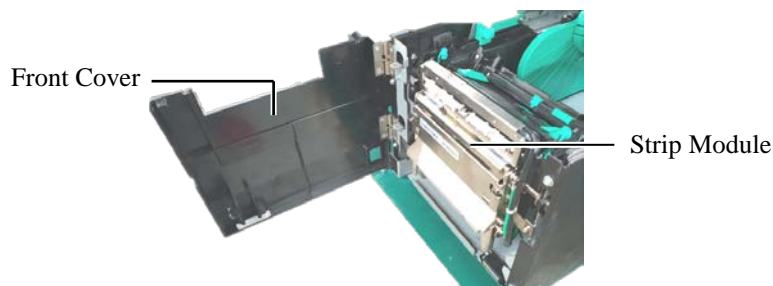

⚠ WARNING!

Be careful that your fingers, jewellery, clothing, etc., are not draw into the rollers of the Strip Module.

NOTE:

To open and close the Front Cover, first open the Top Cover.

If it is difficult to open the Front Cover, hold the cover handle at the bottom.

2.3 Loading the Media (Cont.)

- (2) Press down the Release Bar to open the Strip Module.

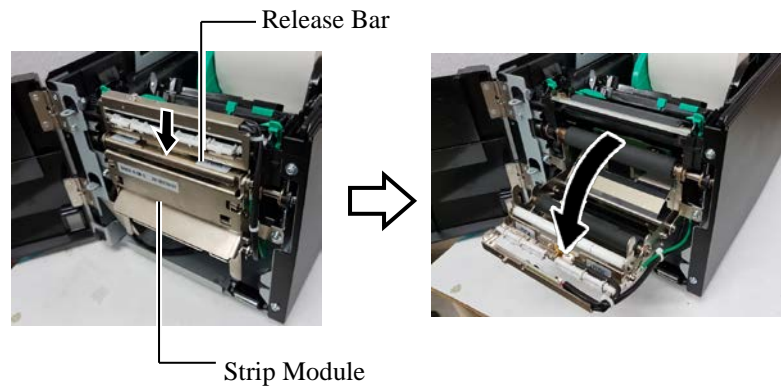

- (3) Remove enough labels from the leading edge of the media to leave 300mm of backing paper free.
 (4) Pass the backing paper through the opening under the Backing Paper Feed Roller. Then, close the Strip Module until it clicks.

NOTE:
 Be sure to close the Strip Module completely. Failure to do this may cause a paper jam.

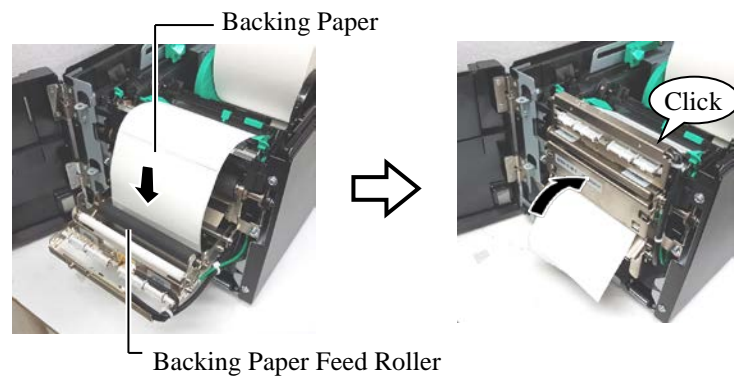

- (5) Insert the leading edge of the backing paper into the slot of the Front Cover.
 (6) Close the Front Cover and the Top Cover.

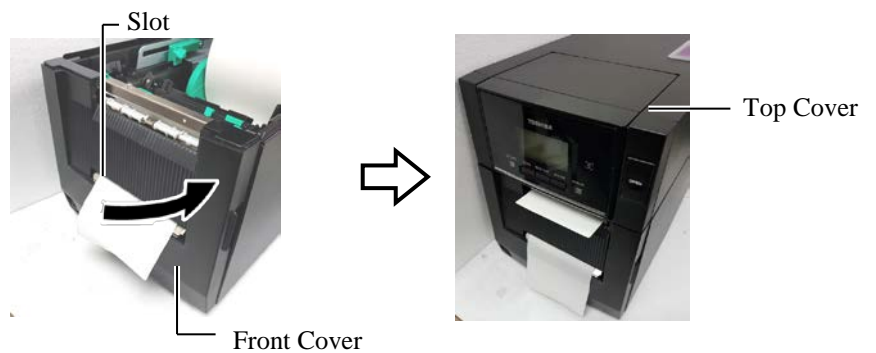

2.3 Loading the Media (Cont.)

⚠ WARNING!
The cutter is sharp, so care must be taken not to injure your fingers when handling the cutter.

⚠ CAUTION!

1. *When using a label stock, be sure to cut the gaps. Cutting labels will cause the glue to stick to the cutter, which may affect the cutter quality and shorten the cutter life.*
2. *Use of tag paper which thickness exceeds specified value may affect the cutter life.*

NOTES:

1. *Be sure to set both Head Position Levers in the same direction. Failure to do this may cause blurred printing.*
2. *Do not leave the Head Position Levers positioned at the middle. When closing the Top Cover, they block the Print Head Positioning Shaft, and the Top Cover cannot be closed.*

Print Head Positioning Shaft

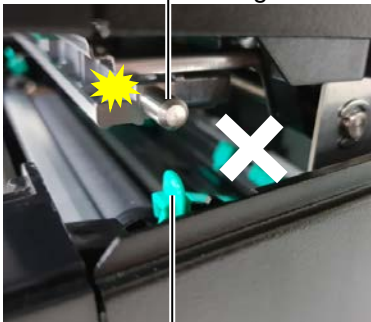

Head Position Lever

Cut mode (Option)

When the optional Cutter Module is fitted, the media is automatically cut.

Insert the leading edge of the media into the Media Outlet of the Cutter Module.

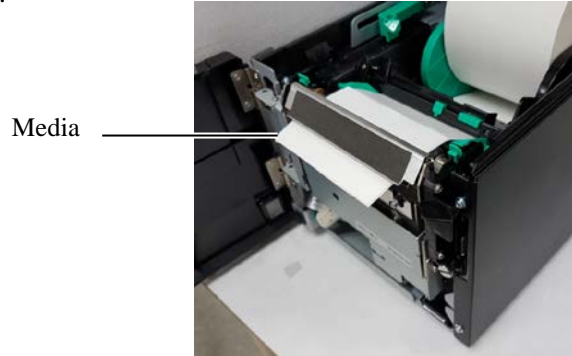

13. Change the print head pressure according to the thickness of the media to be used, by using the Head Position Lever.

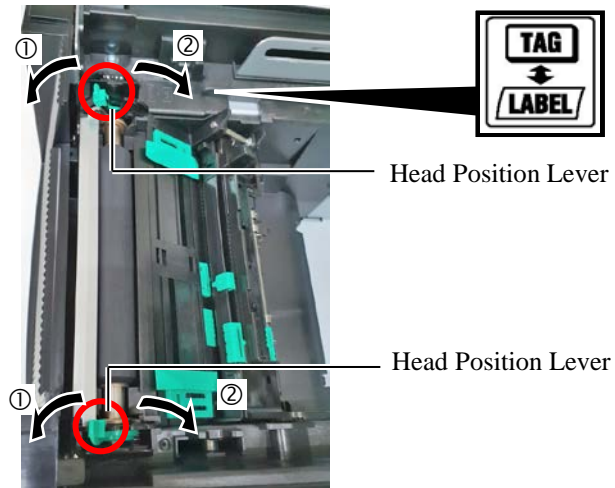

	Media type or thickness	Head Position Lever
① LABEL	Label or Thin media If a clear print cannot be obtained, change the position to ②.	Move the levers toward the front of the printer.
② TAG	Tag paper or Thick paper If a clear print cannot be obtained, change the position to ①.	Move the levers toward the back of the printer.

14. If the loaded media is direct thermal media (with a chemically treated surface), the media loading procedure is now completed. Close the Top Cover.

If the media is normal media, it is also necessary to load a ribbon. Refer to **Section 2.4 Loading the Ribbon.**

2.4 Loading the Ribbon

⚠ WARNING!

1. Do not touch any moving parts. To reduce the risk of fingers, jewellery, clothing, etc., being drawn into the moving parts, be sure to load the ribbon once the printer has stopped moving completely.
2. The print head becomes hot immediately after printing. Allow it to cool before loading the ribbon.
3. To avoid injury, be careful not to trap your fingers while opening or closing the cover.

⚠ CAUTION!

Be careful not touch the Print Head Element when opening the Top Cover. Failure to do this may cause missing dots by static electricity or other print quality problems.

NOTE:

When replacing the ribbon, leave the printer power on. Then, press the [RESTART] key to restart an operation.

There are two types of media available for printing on: these are thermal transfer media (normal media) and direct thermal media (with a chemically treated surface). DO NOT LOAD a ribbon when using a direct thermal media.

1. Press the Top Cover Release Button and gently open the Top Cover to its fully open position supporting it with your hand.



2. Fit the core of the ribbon supply roll into the Ribbon Holders (Supply side), aligning the notch of the ribbon core with the protrusion of the Ribbon Stopper.

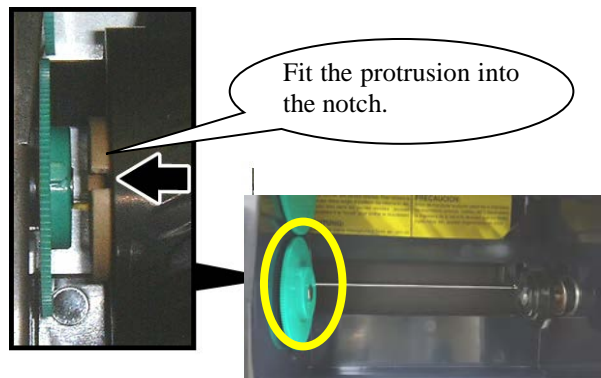
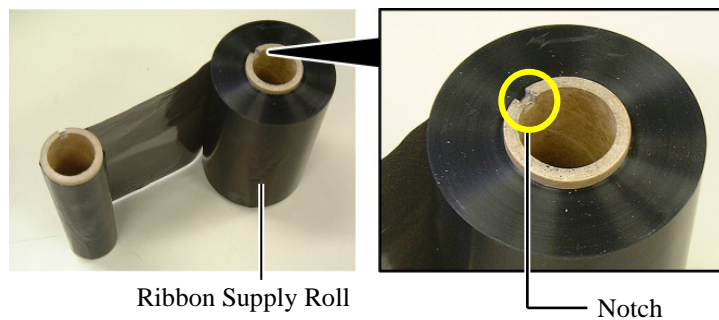
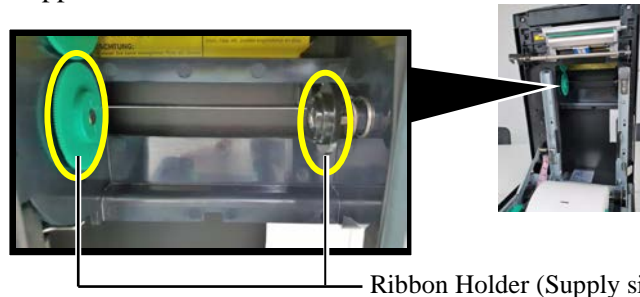

2.4 Loading the Ribbon (Cont.)

3. Open the Top Cover.

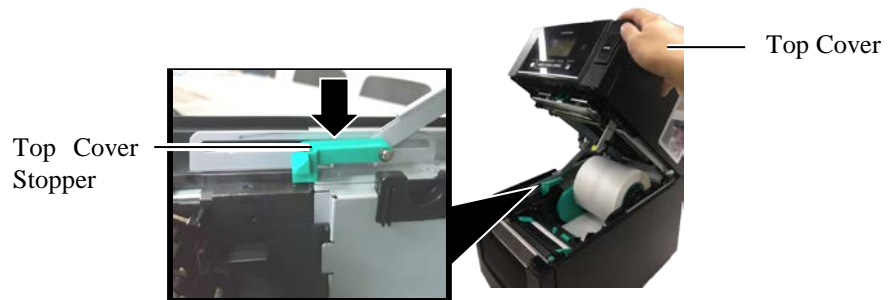

4. Open the Ribbon Cover.



5. Fit the ribbon take-up core into the Ribbon Holder (Take-up side), aligning the notch of the ribbon core with the protrusion of the Ribbon Stopper.

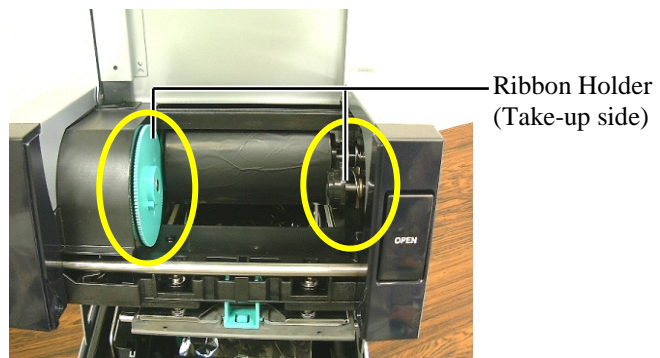

NOTES:

1. Be sure to remove any slack in the ribbon when printing. Printing with a wrinkled ribbon will lower the print quality.
2. When a ribbon end is detected, "RIBBON ERROR" message will appear on the display and the ERROR LED will illuminate.
3. When disposing of the ribbons, please follow the local rules.

6. Turn the ribbon take-up core in the direction indicated by the arrow to remove any slack.

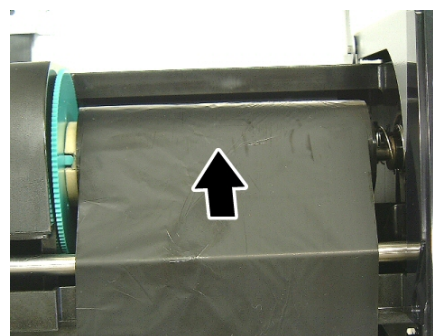

2.4 Loading the Ribbon (Cont.)

⚠ WARNING!

Be sure to close the Ribbon Cover before closing the Top Cover. It is dangerous to close the Top Cover with the Ribbon Cover opened, as the Ribbon Cover slams shut.

7. Close the Ribbon Cover until it clicks.

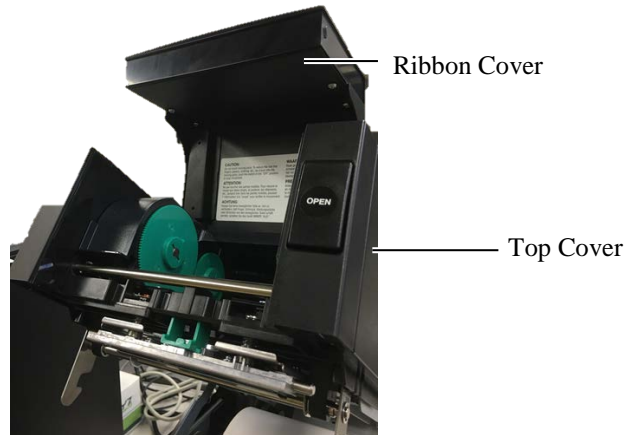

8. Gently close the Top Cover until it clicks.



2.5 Connecting the Printer to Your Host Computer

The following paragraphs outline how to connect your host computer to the printer, and will also show how to make cable connections to other devices. Depending on the system configuration you use to print labels, there are 6 possibilities for connecting the printer to your host computer. These are:

- A parallel cable connection between the printer's optional parallel connector and your host computer's parallel port (LPT). <Option>
- An Ethernet connection using the standard LAN board.
- A USB cable connection between the printer's standard USB connector and your host computer's USB port. (Conforming to USB 2.0 High Speed)
- A serial cable connection between the printer's optional RS-232C serial connector and one of your host computer's COM ports. <Option>
- Wireless LAN using an optional Wireless LAN board. <Option>
- Connect to the printer via the Standard Bluetooth Interface

For details of each interface, refer to **APPENDIX 1**.

After connecting the necessary interface cables, set an operating environment of the printer.

The diagram below shows all the possible cable connections to the current version of the printer.

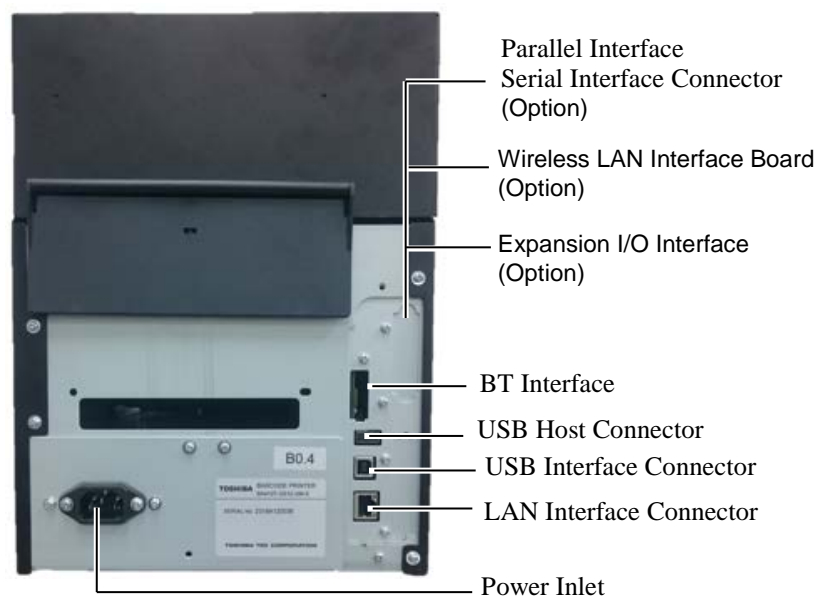

2.6 Turning the Printer ON

When the printer is connected to your host computer it is good practice to turn the printer ON before turning on your host computer and turn OFF your host computer before turning off the printer.

1. To turn ON the printer power, push and hold the Power Switch to approximately 3 seconds as shown in the diagram below.



Power Switch

⚠ CAUTION!

Use the power switch to turn the printer On/Off. Plugging or unplugging the Power Cord to turn the printer On/Off may cause fire, an electric shock, or damage to the printer.

NOTES:

1. If a message other than ON LINE appears on the display or the ERROR LED (Orange) is illuminated, go to Section 4.1, Error Messages.
2. To turn OFF the printer power, push and hold the Power Switch to approximately 3 seconds.

2. Check that the ON LINE message appears in the LCD Message Display and that the ON LINE LED (Blue) is illuminated.



3. MAINTENANCE

⚠ WARNING!

1. Be sure to disconnect the power cord before performing maintenance. Failure to do this may cause an electric shock.
2. To avoid injury, be careful not to pinch your fingers while opening or closing the cover and print head block.
3. The print head becomes hot immediately after printing. Allow it to cool before performing any maintenance.
4. Do not pour water directly onto the printer.

This chapter describes how to perform routine maintenance. To ensure the continuous high quality operation of the printer, refer to the following table and perform a regular maintenance routine.

Cleaning cycle	Frequency
High throughput	Every day
Every ribbon roll or media roll	Once

3.1 Cleaning

3.1.1 Print Head/Platen/Sensors

⚠ CAUTION!

1. Do not use any volatile solvent including thinner and benzene, as this may cause discoloration to the cover, print failure, or breakdown of the printer.
2. Do not touch the Print Head Element with bare hands, as static may damage the Print Head.
3. Be sure to use a Print Head Cleaner. Failure to do this may shorten the Print Head life.

NOTE:
A Print Head Cleaner (P/No. 24089500013) is available from your authorised TOSHIBA TEC service representative.

To maintain the printer performance and print quality, please clean the printer regularly, or whenever the media or ribbon is replaced.

1. Turn off the power and unplug the printer.
2. Press the Top Cover Release Button and gently open the Top Cover to its full open position.
3. Remove the ribbon and media from the printer.
4. Clean the Print Head Element with a Print Head Cleaner, or a cotton swab or soft cloth slightly moistened with absolute ethyl alcohol.

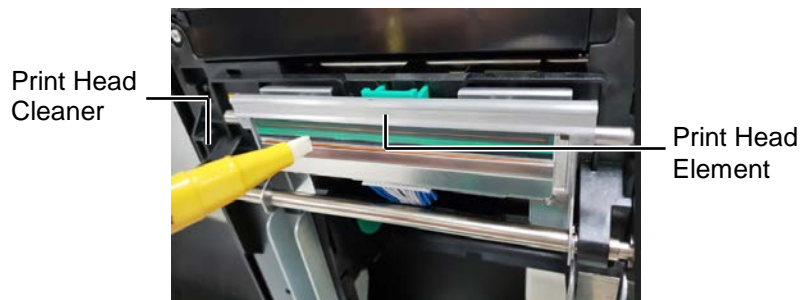

3.1.1 Print Head/Platen/Sensors (Cont.)

5. Wipe the Platen and Dumper Roller with a soft cloth slightly moistened with absolute ethyl alcohol. Remove dust or foreign substances from the internal part of the printer.
6. Wipe the Feed Gap Sensor and Black Mark Sensor with a dry soft cloth.
7. Wipe the media path.

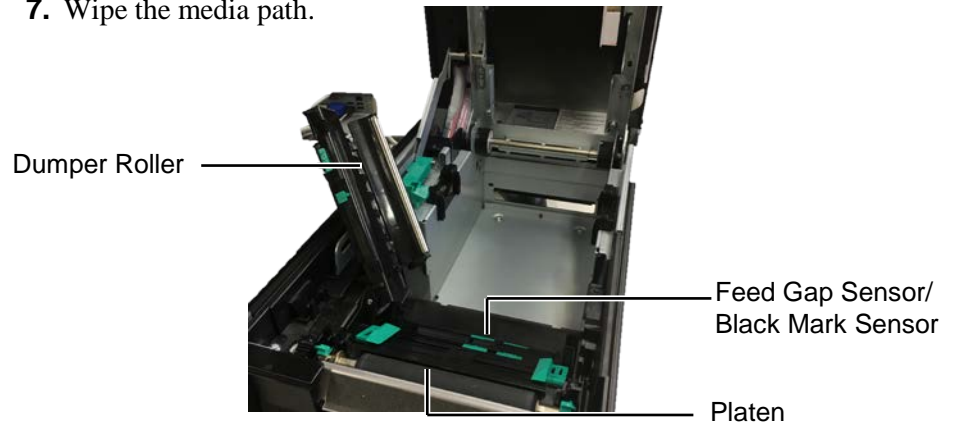

3.1.2 Covers and Panels

⚠ CAUTION!

1. **DO NOT POUR WATER** directly onto the printer.
2. **DO NOT APPLY** cleaner or detergent directly onto any cover or panel.
3. **NEVER USE THINNER OR OTHER VOLATILE SOLVENT** on the plastic covers.
4. **DO NOT** clean the panel, covers, or the supply window with alcohol as it may cause them to discolour, loose their shape or develop structural weakness.

Wipe the covers and panels with a dry soft cloth or a cloth slightly moistened with mild detergent solution.



3.1.3 Optional Cutter Module

1. Open the Front Cover. (*Note)
2. Loosen the Set Screw of the Cutter Module to open it.
3. Remove jammed media, if any.

NOTE:
 To open and close the Front Cover, first open the Top Cover.
 If it is difficult to open the Front Cover, hold the cover handle at the bottom.

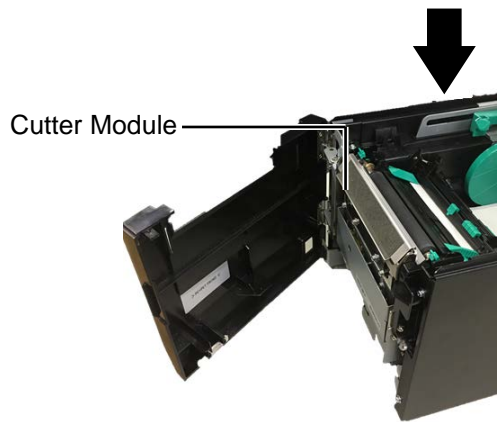
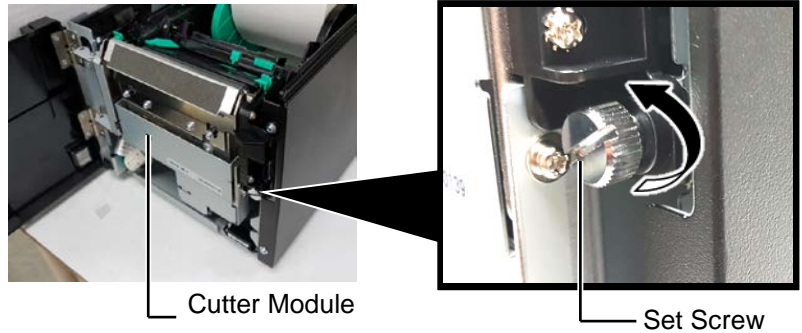

4. Clean the inside of the Cutter Blade with a cotton swab moistened with absolute ethyl alcohol. The cutter blade moves up and down when the Cutter Motor Shaft is rotated manually.

⚠ WARNING!
 As the cutter blade is sharp, care should be taken not to injure yourself when cleaning.

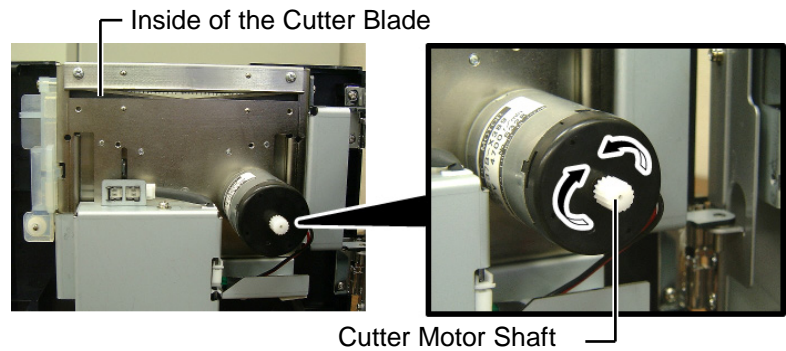

5. In the same way, clean the outside of the Cutter Blade.

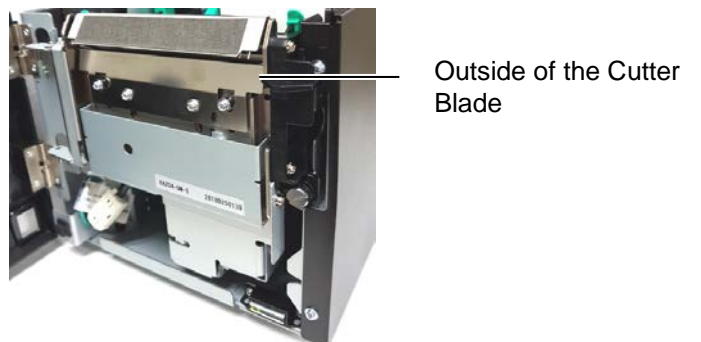

3.1.4 Optional Strip Module

1. Open the Front Cover holding its right side. (*Note)

NOTE:
To open and close the Front Cover, first open the Top Cover.

If it is difficult to open the Front Cover, hold the cover handle at the bottom.

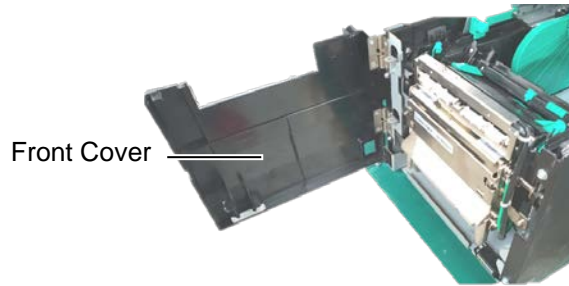

2. Press down the Release Bar to open the Strip Module.

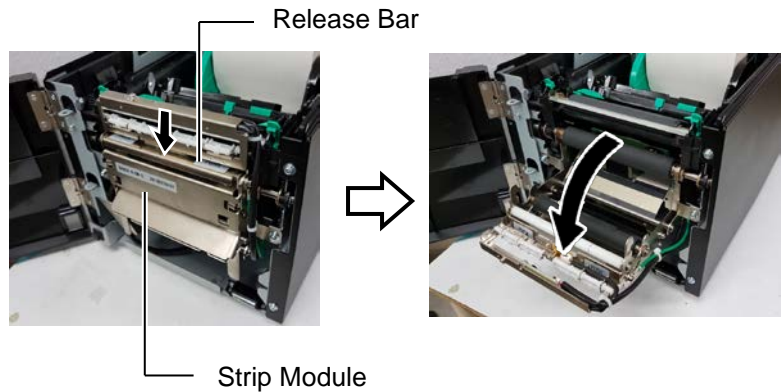

3. Remove jammed media or backing paper, if any
4. Wipe the Backing Paper Feed Rollers, Guide Roller, and Strip Roller with a soft cloth slightly moistened with absolute ethyl alcohol.

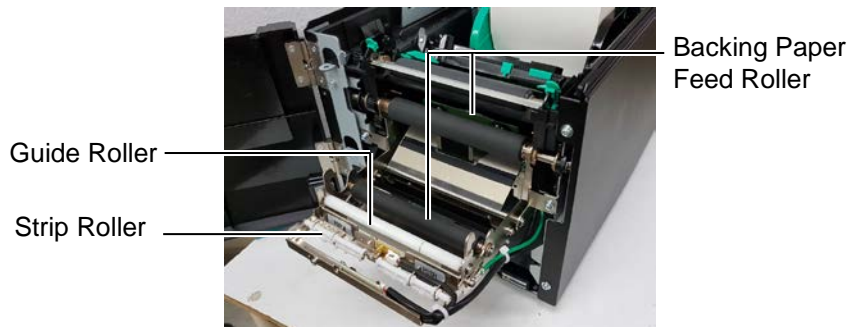

4. TROUBLESHOOTING

This chapter lists the error messages, possible problems, and their solutions.

WARNING!

If a problem cannot be solved by taking the actions described in this chapter, do not attempt to repair the printer. Turn off and unplug the printer, then contact an authorized TOSHIBA TEC service representative

4.1 Error Messages

NOTES:

1. If an error is not cleared by pressing the **[RESTART]** key, turn the printer off and then on.
2. After the printer is turned off, all print data in the printer is cleared.

Error Messages	Problems/Causes	Solutions
HEAD OPEN	The Top Cover is opened in Online mode.	Close the Top Cover.
HEAD OPEN	A feed or an issue was attempted with the Top Cover opened.	Close the Top Cover. Then press the [RESTART] key.
COVER OPEN	A feed or an issue was attempted with the Front Cover opened.	Close the Front Cover, then press the [RESTART] key.
COMMS ERROR	A communication error has occurred.	Make sure the interface cable is correctly connected to the printer and the host, and the host is turned on.
PAPER JAM	1. The media is jammed in the media path. The media is not fed smoothly.	1. Remove the jammed media, and clean the Platen. Then reload the media correctly. Finally press the [RESTART] key.
	2. A wrong Media Sensor is selected for the media being used.	2. Turn the printer off and then on. Then select the Media Sensor for the media being used. Finally resend a print job.
	3. The Black Mark Sensor is not correctly aligned with the Black Mark on the media.	3. Adjust the sensor position. Then press the [RESTART] key. ⇒ Section 2.3.
	4. Size of the loaded media is different from the programmed size.	4. Replace the loaded media with one that matches the programmed size then press the [RESTART] key, or turn the printer off and then on, select a programmed size that matches the loaded media. Finally resend the print job.
	5. The Upper Sensor and the Lower Sensor misalign with each other.	5. Align the Upper Sensor with the Lower Sensor. ⇒ Section 2.3.
	6. The printer used the media which included Black mark and Gap with "CALIBRATE" setting is "ON ALL" or "ON ALL + BackFeed".	6. In order to use this media and Automatic Calibration, "CALIBRATE" setting should be set "ON REFLECTIVE" or "ON REFL + BackFeed". Regarding to setting, please refer to BA400 Series Key Operation Specification

4.1 Error Messages (Cont.)

Error Messages	Problems/Cause	Solutions
CUTTER ERROR (When an optional cutter module is installed.)	The media is jammed in the cutter.	Remove the jammed media. Then press the [RESTART] key. If this does not solve the problem, turn off the printer, and call a TOSHIBA TEC authorised service representative.
NO PAPER	1. The media has run out.	1. Load new media. Then press the [RESTART] key. ⇒ Section 2.3.
	2. The media is not loaded properly.	2. Reload the media correctly. Then press the [RESTART] key. ⇒ Section 2.3.
	3. The media is slack.	3. Take up any slack in the media.
RIBBON ERROR	1. The ribbon is not fed properly.	1. Remove the ribbon, and check the status of the ribbon. Replace the ribbon, if necessary. If the problem is not solved, turn off the printer, and call a TOSHIBA TEC authorised service representative.
	2. The ribbon has run out.	2. Load a new ribbon. Then press the [RESTART] key. ⇒ Section 2.4.
EXCESS HEAD TEMP	The Print Head has overheated.	Turn off the printer, and allow it to cool down (about 3 minutes). If this does not solve the problem, call a TOSHIBA TEC authorised service representative.
HEAD ERROR	There is a problem with the Print Head.	The Print Head is required to be replaced. Call a TOSHIBA TEC authorized service representative.
SYSTEM ERROR	1. The printer is used in a location where it is subject to noise. Or, there are power cords of other electrical appliances near the printer or interface cable.	1. Keep the printer and the interface cables away from the source of noise.
	2. The Power Cord of the printer is not grounded.	2. Ground the Power Cord.
	3. The printer shares the same power source with any other electrical appliances.	3. Provide an exclusive power source for the printer.
	4. An application software used on your host computer has an error or malfunction.	4. Confirm the host computer operates properly.
FLASH WRITE ERR.	An error has occurred in writing to the flash ROM.	Turn the printer off, and then on again.
FORMAT ERROR	An error has occurred in formatting the flash ROM.	Turn the printer off, and then on again.
MEMORY FULL	Saving failed because of an insufficient capacity of the flash ROM.	Turn the printer off, and then on again.
RFID WRITE ERROR	The printer did not succeed in writing data onto an RFID tag after having retried for a specified times.	Press the [RESTART] key.

4.1 Error Messages (Cont.)

Error Messages	Problems/Cause	Solutions
RFID ERROR	The printer cannot communicate with the RFID module.	Turn the printer off, and then on again.
SYNTAX ERROR	While the printer is in the Download mode for upgrading the firmware, it receives an improper command, for example, an Issue Command.	Turn the printer off, and then on again.
POWER FAILURE	A momentary power failure has occurred.	Check the power source which supplies power to the printer. If the rating is not correct, or if the printer shares the same power outlet with other electrical appliances that consume large amounts of power, change the outlet.
LOW BATTERY	The voltage of the Real Time Clock Battery is 1.9V or less.	Hold down the [RESTART] key until “<1>RESET” is displayed. If you would like to keep using the same battery even after “LOW BATTERY” error occurs, set the Low battery check function to OFF, and set the date and time to the real time. As long as the power is on, the Real Time Clock will function. However, once the power is turned off, the date and time will be reset. Call a TOSHIBA TEC authorized service representative for replacement of the battery.
Other error messages	A hardware or software problem may have occurred.	Turn the printer off and then on. If this does not solve the problem, turn off the printer again, and call a TOSHIBA TEC authorised service representative.

4.2 Possible Problems

This section describes problems that may occur when using the printer, and their causes and solutions.

Possible Problems	Causes	Solutions
The printer will not turn on.	1. The Power Cord is disconnected.	1. Plug in the Power Cord.
	2. The AC outlet is not functioning correctly.	2. Test with a power cord from another electric appliance.
	3. The fuse has blown, or the circuit breaker has tripped.	3. Check the fuse or breaker.
The media is not fed.	1. The media is not loaded properly.	1. Load the media properly. ⇒ Section 2.3.
	2. The printer is in an error condition.	2. Solve the error in the message display.
Pressing the [FEED] key in the initial state results in an error.	A feed or an issue was attempted not on the following default conditions. Sensor type: Feed gap sensor Printing method: Thermal transfer Media pitch: 76.2 mm	Change the print condition by using the printer driver or a print command so that it corresponds to your printing conditions. Then, clear the error state by pressing the [RESTART] key.

4.2 Possible Problems (Cont.)

This section describes problems that may occur when using the printer, and their causes and solutions.

Possible Problems	Causes	Solutions
Nothing is printed on the media.	1. The media is not loaded properly.	1. Load the media properly. ⇒ Section 2.3.
	2. The ribbon is not loaded properly.	2. Load the ribbon properly. ⇒ Section 2.4.
	3. The ribbon and media are not matched.	3. Select an appropriate ribbon for the media type being used.
The printed image is blurred.	1. The ribbon and media are not matched.	1. Select an appropriate ribbon for the media type being used.
	2. The Print Head is not clean.	2. Clean the print head using a Print Head Cleaner or a cotton swab slightly moistened with ethyl alcohol.
The optional cutter module does not cut.	1. The Cutter Module is not closed properly.	1. Close the Cutter Module properly.
	2. The media is jammed in the Cutter.	2. Remove the jammed paper..
	3. The cutter blade is dirty.	3. Clean the cutter blade.

4.3 Removing Jammed Media

This section describes in detail how to remove jammed media from the printer.

⚠ CAUTION!
Do not use any tool that may damage the Print Head.

NOTE:
If you get frequent jams in the cutter, contact a TOSHIBA TEC authorised service representative.

1. Turn off and unplug the printer.
2. Press the Top Cover Release Button and gently open the Top Cover to its fully open position supporting it with your hand.
3. Press the Upper Sensor Lever inside, and open the Upper Sensor Ass’y.
4. Remove the ribbon and media from the printer.

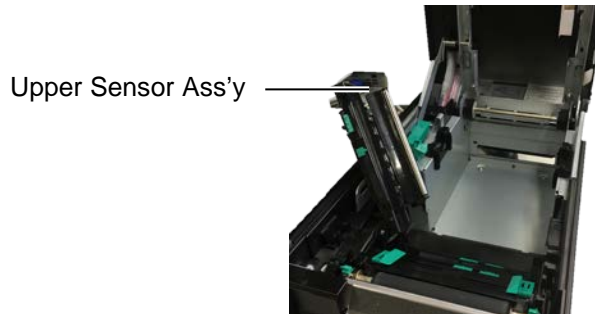

5. Remove the jammed media from the printer. DO NOT USE any sharp implements or tools as these could damage the printer.
6. Clean the Print Head and Platen, then remove any further dust or foreign substances.
7. Paper jams in the Cutter Module can be caused by wear or residual glue from label stock on the cutter. Do not use non-specified media in the cutter.

5. PRINTER SPECIFICATIONS

This section describes the printer specifications.

Model		BA410T-GS12-QM-S	BA410T-TS12-QM-S
Item			
Dimension (W × D × H)		238 mm × 401.7 mm × 331.5 mm (9.4" × 15.8" × 13.1")	
Weight		33.1 lb (15 kg) (Media and ribbon are not included.)	
Operating temperature range	Thermal direct	0°C to 40°C (32°F to 104°F)	
	Thermal transfer	5°C to 40°C (41°F to 104°F)	
Relative humidity		25% to 85% RH (no condensation)	
Power supply		Universal power source AC100V to 240V, 50/60Hz±10%	
Input voltage		AC100 to 240V, 50/60Hz ±10%	
Power consumption	During a print job*1	2.1A (100V) to 1.1A (240V), 155W rating	
	During standby	0.19A (100V) to 0.15A (240V), 13W (100V) to 22W (240V)	
Resolution		8 dots/mm (203 dpi)	11.8 dots/mm (300 dpi)
Printing method		Thermal transfer or Thermal direct	
Printing speed		50.8 mm/sec. (2 inches/sec.) *2 203.2 mm/sec (8 inches/sec) 101.6 mm/sec (4 inches/sec.) 152.4 mm/sec (6 inches/sec.)	
Available media width (including backing paper)	Thermal direct	25.0 mm to 118.0 mm (1 inch to 4.6 inches)	
	Thermal transfer	25.0 mm to 114.0 mm (1 inch to 4.5 inches)	
Maximum effective print width		104.0 mm (4.1 inches)	105.7 mm (4.2 inches)
Issue mode		Batch, Strip (option), and Cut (option)	
LCD Message display		Graphic type 128 x 64 dots	

*1: While 30% slant lines are printed in the specified format.

*2: When select 2"/sec on thermal transfer mode , it will print at 3"/sec.

Model	BA410T-GS12-QM	BA410T-TS12-QM
Item		
Available bar code types	JAN8, JAN13, EAN8, EAN8+2 digits, EAN8+5 digits, EAN13, EAN13+2 digits, EAN13+5 digits, UPC-E, UPC-E+2 digits, UPC-E+5 digits, UPC-A, UPC-A+2 digits, UPC-A+5 digits, MSI, ITF, NW-7, CODE39, CODE93, CODE128, EAN128, Industrial 2 to 5, Customer Bar Code, POSTNET, KIX CODE, RM4SCC (ROYAL MAIL 4STATE CUSTOMER CODE), GS1 DataBar, MATRIX 2 of 5 for NEC,	
Available two-dimensional code	Data Matrix, PDF417, QR code, Maxi Code, Micro PDF417, CP Code, Security QR code, Aztec, GS1 Data Matrix	
Available font	Times Roman (6 sizes), Helvetica (6 sizes), Presentation (1 size), Letter Gothic (1 size), Prestige Elite (2 sizes), Courier (2 sizes), OCR (2 types), Gothic (1 size), Outline font (4 types), Price font (3 types)	
Rotations	0°, 90°, 180°, 270°	
Standard interface	USB interface (V2.0 High speed) LAN interface (10/100BASE) Bluetooth interface(2400MHz ~ 2483.5MHz , CLASS2(2.5mW)) NFC(MIFARE (ISO/IEC 14443 TypeA)) USB Host Interface	
Optional equipment	Cutter module (BA204-QM-S) Strip module (BA904-H-QM-S) Serial Interface Board (BA700-RS-QM-S) Wireless LAN Board (BA700-WLAN-QM-S) Expansion I/O Board (BA700-IO-QM-S) Real Time Clock (BA700-RTC-QM-S) Fan Fold Guide (BA904-FF-QM-S) Parallel Interface (CEN) (BA700-CEN-QM-S) UHF RFID Module (BA704-RFID-U4-KR-S, BA704-RFID-U4-EU-S, BA704-RFID-U4-AU-S)	

NOTES:

- *Data Matrix™ is a trademark of International Data Matrix Inc., U.S.*
- *PDF417™ is a trademark of Symbol Technologies Inc., US.*
- *QR Code is a trademark of DENSO CORPORATION.*
- *Maxi Code is a trademark of United Parcel Service of America, Inc., U.S.*

6. APPENDIX 1 INTERFACE

NOTE:

To prevent radiation and reception of electrical noise, the interface cables must meet the following requirements:

- In case of a parallel interface cable or serial interface cable, fully shielded and fitted with metal or metallised connector housings.
- Keep as short as possible.
- Should not be bundled tightly with power cords.
- Should not be tied to power line conduits.
- A parallel interface cable to be used should conform to IEEE1284.

USB interface (Standard)

Standard: Conforming to V2.0 High speed
 Transfer type: Control transfer, Bulk transfer
 Transfer rate: 480M bps
 Class: Printer class
 Control mode: Status with the receive buffer free space information
 Number of ports: 1
 Power source: Self power
 Connector: Type A and Type B

Pin No.	Signal
1	VCC
2	D-
3	D+
4	GND

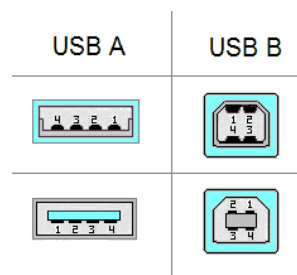

LAN (Standard)

Standard: IEEE802.3 10BASE-T/100BASE-TX
 Number of ports: 1
 Connector: RJ-45
 LED status: Link LED
 Activity LED

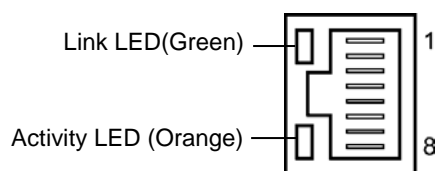

LED	LED Status	LAN status
Link	ON	10Mbps link or 100Mbps link is detected.
	OFF	No link is detected. * Communication cannot be made while the Link LED is off.
Activity	ON	Communicating
	OFF	Idle

LAN cable: 10BASE-T: UTP category 3 or category 5
 100BASE-TX: UTP category 5
 Cable length: Segment length Max. 100 m

Bluetooth (Standard)

Module Name:	MBH7BTZ42
Bluetooth version:	V2.1 + EDR
Frequency:	2.4000 to 2.4835 GHz
Maximum Transmit:	Class 2
Power:	+4dBm (Except antenna gain)
Receive Sensitivity:	-87 dBm
Data Rates:	1Mbps (Basic Rate)/2Mbps (EDR 2Mbps)/3Mbps (EDR 3Mbps)"
Communication distance:	3m/360deg (For BA400 specification)
Certification (Module):	TELEC/FCC/IC/EN
Antenna specification:	Mono-pole antenna
Peak Gain:	-3.6dBi (2.4GHz)

NFC

Communication standard:	MIFARE (ISO/IEC 14443 Type A)
Memory size:	It is possible to write in NFC tag.
Operation frequency:	13, 56 MHz

■ Optional Serial Interface BA700-RS-QM-S

Type:	RS-232C
Communication mode:	Full duplex
Transmission speed:	2400 bps, 4800 bps, 9600 bps, 19200 bps, 38400 bps, 115200 bps
Synchronization:	Start-stop synchronization
Start bit:	1 bit
Stop bit:	1 bit, 2 bit
Data length:	7 bit, 8 bit
Parity:	None, EVEN, ODD
Error detection:	Parity error, Framing error, Overrun error
Protocol:	Unprocedure communication
Data input code:	ASCII code, European character 8 bit code, graphic 8 bit code, JIS8 code, Shift JIS Kanji code, JIS Kanji code
Receive buffer:	1M byte
Connector:	

Pin No.	Signal
1	N.C
2	TXD (Transmit Data)
3	RXD (Received Data)
4	DSR (Data Set Ready)
5	SG (Signal Ground)
6	DTR (Data Terminal Ready)
7	CTS (Clear to Send)
8	RTS (Request to Send)
9	N.C

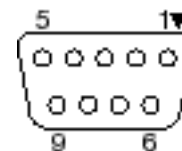

■ Optional Parallel Interface BA700-CEN-QM-S

Mode: Conforming to IEEE1284
Compatible mode (SPP mode), Nibble mode

Data input method: 8 bit parallel

Control signal:

SPP Mode	Nibble Mode
nStrobe	HostClk
nAck	PtrClk
Busy	PtrBusy
Perror	AckDataReq
Select	Xflag
nAutoFd	HostBusy
nInit	nInit
nFault	nDataAvail
nSelectIn	IEEE1284Active

Data input code: ASCII code
European 8 bit code
Graphic 8 bit code
JIS8 code
Shift JIS Kanji code
JIS Kanji code

Receive buffer: 1MB

Connector:

PIN No.	Signal	
	SPP Mode	Nibble Mode
1	nStrobe	HostClk
2	Data 1	Data 1
3	Data 2	Data 2
4	Data 3	Data 3
5	Data 4	Data 4
6	Data 5	Data 5
7	Data 6	Data 6
8	Data 7	Data 7
9	Data 8	Data 8
10	nAck	PtrClk
11	Busy	PtrBusy
12	PError	AckDataReq
13	Select	Xflag
14	nAutoFd	HostBusy
15	NC	NC
16	0V	0V
17	CHASSIS GND	CHASSIS GND
18	+5V (For detection)	+5V (For detection)
19	TWISTED PAIR GND(PIN1)	TWISTED PAIR GND(PIN1)
20	TWISTED PAIR GND(PIN2)	TWISTED PAIR GND(PIN2)
21	TWISTED PAIR GND(PIN3)	TWISTED PAIR GND(PIN3)
22	TWISTED PAIR GND(PIN4)	TWISTED PAIR GND(PIN4)
23	TWISTED PAIR GND(PIN5)	TWISTED PAIR GND(PIN5)
24	TWISTED PAIR GND(PIN6)	TWISTED PAIR GND(PIN6)
25	TWISTED PAIR GND(PIN7)	TWISTED PAIR GND(PIN7)
26	TWISTED PAIR GND(PIN8)	TWISTED PAIR GND(PIN8)

27	TWISTED PAIR GND(PIN9)	TWISTED PAIR GND(PIN9)
28	TWISTED PAIR GND(PIN10)	TWISTED PAIR GND(PIN10)
29	TWISTED PAIR GND(PIN11)	TWISTED PAIR GND(PIN11)
30	TWISTED PAIR GND(PIN31)	TWISTED PAIR GND(PIN31)
31	nInit	nInit
32	nFault	NDataAvail
33	0V	0V
34	NC	NC
35	NC	NC
36	nSelectIn	IEEE1284Active

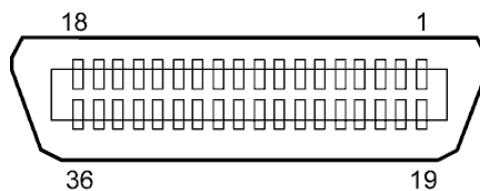

IEEE1284-B Connector

■ Optional WLAN Interface BA700-WLAN-QM-S

Module Name:	RS9113DB
Standard:	IEEE802.11 a / b / g / n
Frequency:	"2412 MHz – 2484 MHz/4910 MHz – 5825 MHz"
Spacing:	5 MHz (2.4GHz), 20 MHz (5GHz)
Channel:	US : 1 - 11, 36 - 48, 52 - 64, 100 - 116, 120 - 128, 132 - 140, 149 - 165 Europe : 1- 13, 36 - 48, 52 - 64, 100 - 140 Japan : 1 - 14, 36 - 48, 52 - 64, 100 - 140
Antenna:	integrated antenna
Communication speed/Modulation	802.11b: 1, 2, 5.5, 11 Mbps 802.11g: 6, 9, 12, 18, 24, 36, 48, 54 Mbps 802.11n: MCS0 to MCS7 with and without Short GI" OFDM with BPSK, QPSK, 16-QAM, and 64-QAM 802.11b with CCK and DSSS"
Receive Sensitivity:	-97 dBm
Transmission output:	17 dBm

⚠ WARNING!

Do not use the 5GHz band for communication outdoors. Using wireless devices outdoors on the 5GHz band is prohibited. To operate the wireless LAN of this product outdoors, only use the 2.4GHz band.

■ **Optional EX I/O Module BA700-IO-QM-S**

Input Signal IN0 to IN5
 Output Signal OUT0 to OUT6
 Connector FCN-781P024-G/P or equivalent
 (External Device Side)
 Connector FCN-685J0024 or equivalent
 (Printer Side)

Pin	Signal	I/O	Function	Pin	Signal	I/O	Function
1	IN0	Input	FEED	13	OUT6	Output	
2	IN1	Input	PRINT	14	N.C.	-----	
3	IN2	Input	PAUSE	15	COM1	Common (Power)	
4	IN3	Input		16	N.C.	-----	
5	IN4	Input		17	N.C.	-----	
6	IN5	Input		18	N.C.	-----	
7	OUT0	Output	FEED	19	N.C.	-----	
8	OUT1	Output	PRINT	20	N.C.	-----	
9	OUT2	Output	PAUSE	21	COM2	Common (Ground)	
10	OUT3	Output	ERROR	22	N.C.	-----	
11	OUT4	Output		23	N.C.	-----	
12	OUT5	Output	POWER ON	24	N.C.	-----	

N.C.: No Connection

Input Circuit

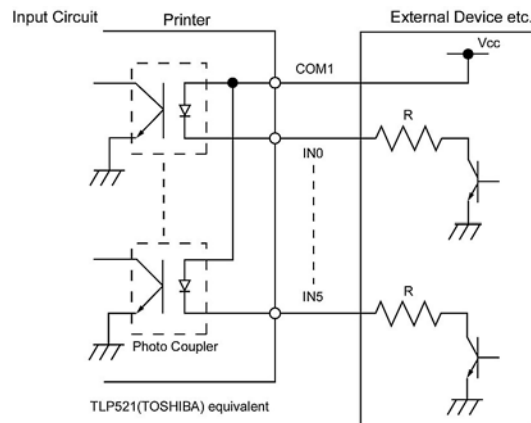

Output Circuit

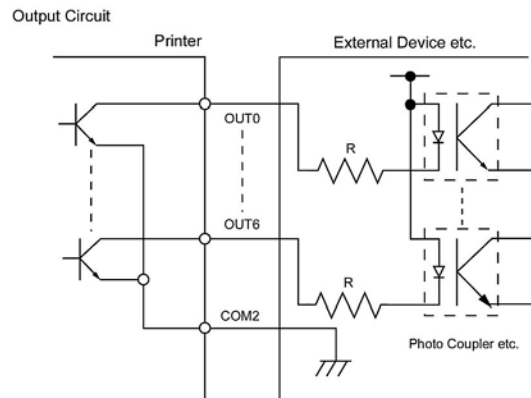

Operating environment Temperature: 0 to 40 °C
 Humidity: 20 to 90% (No Condensation)

■ Optional RFID Module BA704-RFID-U4-KR-S, BA704-RFID-U4-EU-S, BA704-RFID-U4-AU-S**• (Option)BA704-RFID-U4-KR-S**

Module: TRW-USM-10
Frequency: KR settings: 920.9-923.3 MHz (UHF Korea)
Output: 1 to 100 mW
Available RFID tag: EPC C1 Gen2, ISO-18000-6C

• (Option)BA704-RFID-U4-EU-S

Module: TRW-EUM-10
Frequency: 869.85 MHz (UHF Europe)
Output: 1 to 100 mW
Available RFID tag: EPC C1 Gen2, ISO-18000-6C

• (Option)BA704-RFID-U4-AU-S

Module: TRW-USM-10
Frequency: 918.25 -925.75 MHz (UHF Australia)
Output: 1 to 100 mW
Available RFID tag: EPC C1 Gen2, ISO-18000-6C

Cautions for using RFID Tags

(1) Accuracy of encoding

Please note that it cannot guarantee 100% encoding* accuracy for all environment and condition of use. Encoding accuracy may depend on the use of Tag(IC, Inlay design/size) condition, temperature/humidity condition, and other external factors such as extrinsic noise. Please conduct a test in advance at actual using environment.

*Printer issues VOID pattern on the RFID label when encoding fails.

(2) Storage of RFID Media

Do not store RFID tags close to printers, as their read/write performance may be compromised when they are used.

(3) Roll-type RFID Media

When RFID media are to be rolled, roll hardness must be considered.

Although it depends on the type of adhesive, tag, and backing paper, RFID-tag embedded labels tend to stay rolled. Especially, when they are inside wound, a paper jam error may occur. Unless otherwise specified, it is recommended that the RFID-tag embedded labels be outside wound.

(4) Sensor

When the transmissive sensor or reflective sensor is enabled, transmittance or reflectivity of a label or tag may vary at an RFID-tag embedded area depending on the pattern of the antenna or other factors. In such cases, a manual threshold setting is required. For details, please contact the nearest TOSHIBA TEC support representative.

(5) Cutter

When an RFID label or tag is used in cut issue mode, care must be taken not to cut the antenna of the RFID tag or the IC chip so as not to damage the cutter.

(6) Static Electricity

When printing is performed in a place where humidity is low or under some specific conditions, writing data on an RFID tag may fail due to static electricity generated by the label or ribbon.

(7) Printing on Bump (Chip/Antenna) Area

Embedding an RFID tag in labels creates bumps on the label surface, causing incomplete printing. Uneven printing or incomplete printing can occur easily, especially within 5 mm top and bottom, and to the left and right sides of the RFID-tag embedded area, as shown in the figure below.

NOTE: The degree of poor printing quality differs depending on height of a chip/antenna used.

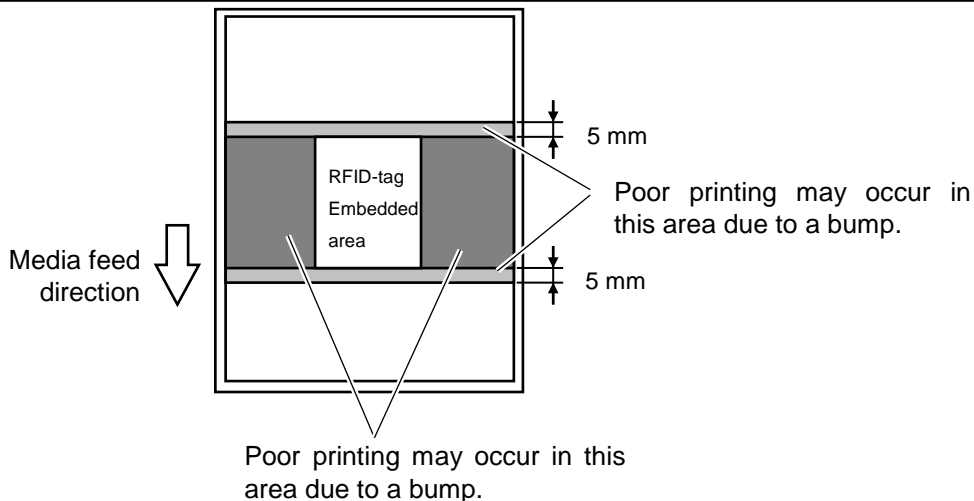

(8) Ambient Temperature

Wireless performance is affected by ambient temperatures, therefore writing data on an RFID tag may fail if ambient temperature changed from at the time of temperature of RFID setting.

(9) Strip Issue

Stripping performance in strip issue mode depends on the type of adhesive, tag, and backing paper. For some RFID media used, a strip issue may not be performed properly.

(10) Caution for Minimum Label Pitch Length

When using media, with a short label pitch length, data may be written on an RFID tag adjacent to the target RFID tag and it may not be able to write on target RFID tag.

As the location, where data is to be written, differs among RFID tag types, a check must be performed to make sure that the data is written on the target RFID tags. The BCP RFID Analyze Tool can be used for this purpose. For details, please contact the nearest TOSHIBA TEC support representative.

(11) Defective RFID Media

RFID media may include defective RFID tags at the time of shipment from the maker. The defect rate differs depending on tag types, method of converting to media, etc.

The RFID media manufacturer should provide a way to identify defective tags by printing a mark on them or any other methods.

Or, defective tags should be rejected in the production process.

The end users must be notified on how to identify a defective tag from a good one.

(12) Automatic Calibration(Key Operation:<2>SET PARAMETERS-CALIBRATE)











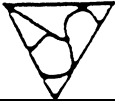







Do not use Automatic Calibration feature for using RFID media.(Please set "CALIBRATE" to OFF)

Regarding to setting this feature, please refer to BA400 Series Key Operation Specification.

7. APPENDIX 2 POWER CORD

When purchasing the power cord:

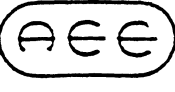
Since the power cord set is not enclosed in this unit, please purchase an approved one that meets the following standard from your authorized TOSHIBA TEC representative.

Country	Agency	Certification mark	Country	Agency	Certification mark	Country	Agency	Certification mark
Australia	SAA		Germany	VDE		Sweden	SEMKKO	
Austria	OVE		Ireland	NSAI		Switzerland	SEV	
Belgium	CEBEC		Italy	IMQ		UK	ASTA	
Canada	CSA		Japan	METI		UK	BSI	
Denmark	DEMKO		Netherlands	KEMA		U.S.A.	UL	
Finland	FEI		Norway	NEMKO		Europe	HAR	
France	UTE		Spain	AEE		Taiwan	CNS	
South Africa	SABS							

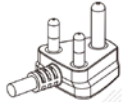
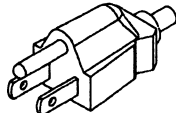
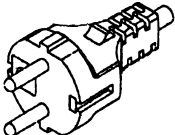
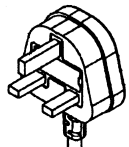
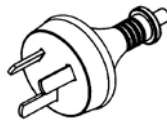
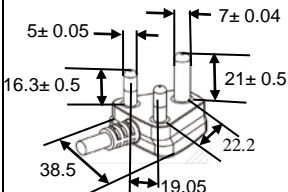
Power Cord Instruction					
1. For use with 100 – 125 Vac mains power supply, please select a power cord rated Min. 125V, 10A. 2. For use with 200 – 240 Vac mains power supply, please select a power cord rated Min. 250V. 3. Please select a power cord with the length of 4.5m or less.					
Country/Region	North America	Europe	United Kingdom	Australia	South Africa
Power Cord Rated (Min.) Type	125V, 10A SVT	250V H05VV-F	250V H05VV-F	250V AS3191 approved, Light or Ordinary Duty type	250V, 6A H05VV 
Conductor size (Min.)	No. 3/18AWG	3 x 0.75 mm ²	3 x 0.75 mm ²	3 x 0.75 mm ²	3 x 0.75 mm ²
Plug Configuration (locally approved type)					
Rated (Min.)	125V, 10A	250V, 10A	250V, *1	250V, *1	



Toshiba Tec Corporation

© 2019 TOSHIBA TEC CORPORATION All Rights Reserved
1-11-1, Osaki, Shinagawa-ku, Tokyo 141-8562, JAPAN

EN PRINTED IN INDONESIA
EO1-33122